



WHITE ELEPHANT GMBH

SkyTrack

Reference Manual

Urs Maurer

Version:	Modified:	
1.0	5-Oct-17	Original Issue
1.1	21-Dec-17	LX 200 protocol support
1.2	25-Oct-18	New SkyTracker hardware
1.3	8-Jan-19	Support different steps/rev per axis
1.4	31-May-19	Allow synch on targets
1.5	20-Jan-21	Equatorial mounts only

Table of Contents

1	Introduction	1
2	Getting Started.....	1
3	Configure SkyTrack.....	2
3.1	Locate the configuration data directory.....	2
3.1.1	OSX.....	2
3.1.2	Linux.....	2
3.1.3	Windows 10.....	2
3.2	Contents of SkyTrack data directory.....	3
3.2.1	Program configuration data (SkyTrack.ini)	3
3.2.2	Favorites list of Sky Objects (Favorites.txt).....	6
3.2.3	Solar Objects.....	6
3.2.4	Small Solar System Bodies (SSSB)	7
3.2.5	Objects from Catalogs.....	7
3.2.6	Sky Objects.....	7
3.2.7	On Earth Objects.....	7
3.3	Small Solar System Bodies.....	8
3.3.1	Download Ephemerides.....	8
4	Telescope Setup.....	11
4.1	Display Page.....	11
4.2	Setup Page	12
4.2.1	Image Orientation.....	12
4.2.2	Autoguiding Speed.....	12
4.2.3	Refraction Parameters.....	12
4.2.4	Setup Operation	12
4.3	Pole Axis Alignment	13
4.4	Local Alignment	13
4.5	Global Alignment	14
4.6	Set Sky Line	14
5	Hardware	15
5.1	Stepper Controller.....	15
5.1.1	Power and Ethernet Connections	15
5.1.2	Motor and Guider Connections	16
5.1.3	Stepper Controller Board.....	16
5.2	Handbox	17
5.2.1	Handbox Inside	18
5.2.2	Handbox Schematics.....	19
6	Legacy Hardware.....	20
6.1	Stepper Controller.....	20
6.1.1	Stepper Controller Board.....	20

1 Introduction

SkyTrack is a PC program that is able to control the movement of a telescope to find and follow stars, planets, deep sky objects, small solar system bodies (SSSB) such as comets or near earth objects such as satellites.

The program supports telescopes that have simple stepper motors (without decoders) with Equatorial mountings.

The telescope can be controlled using the program's graphical user interface (GUI), a numeric keypad or via Stellarium. In the latter case the program sends feedback to Stellarium so that it can keep its display up to date. The use of Stellarium is not a requirement.

Other features that are often missing from contemporary products include:

- Favorites: a list of frequently observed objects.
- Horizon: For fixed telescopes and those at their "home" location, the actual horizon can be defined. The actual horizon differs from the true horizon when buildings obscure the true horizon. This feature allows the program to improve the accuracy of its filtering of visible objects.
- Only list objects that can currently be seen or, in the case of NEOs, are soon to be seen.
- Catalogs: Objects can be named according to a variety of catalogs. The same astronomical object is called different things according to the catalog used.
- On Earth Objects: For demonstration purposes, when the weather is overcast, it is sometimes useful to be able to position the telescope onto a nearby terrestrial object (e.g. a road sign). In this case the rotation of the earth must be ignored.
- Park position: For fixed telescopes or those at their "home" location, it is useful to park the telescope to a known position before powering off. This saves the need to realign the telescope next time it is used.
- Normal and Expert modes: Useful to prevent shared or public telescopes from being accidentally misconfigured.

2 Getting Started

The easiest way to get SkyTrack running is to follow the instructions of the SkyTrack User Manual.

3 Configure SkyTrack

3.1 Locate the configuration data directory

3.1.1 OSX

First open the application data directory by starting the **Finder's Go to Folder...** and then entering: **~/Library/Application Support**

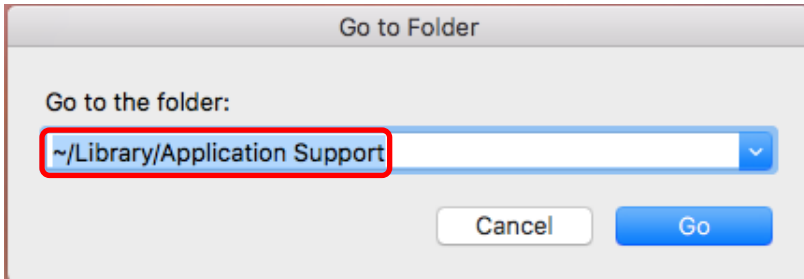

Then browse to the SkyTrack data subdirectory: **White Elephant/SkyTrack**

3.1.2 Linux

First open **Home** and make the hidden directories visible by entering: **Ctrl-h**

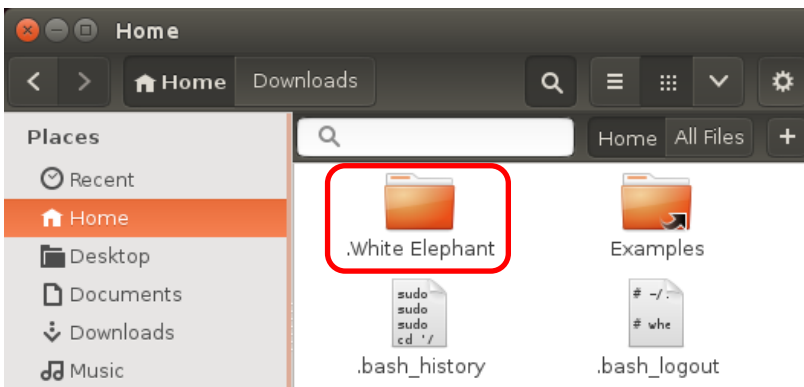

Then browse to the SkyTrack data subdirectory: **.White Elephant** and then **SkyTrack**

3.1.3 Windows 10

First open the application data directory by executing: **explorer %APPDATA%**

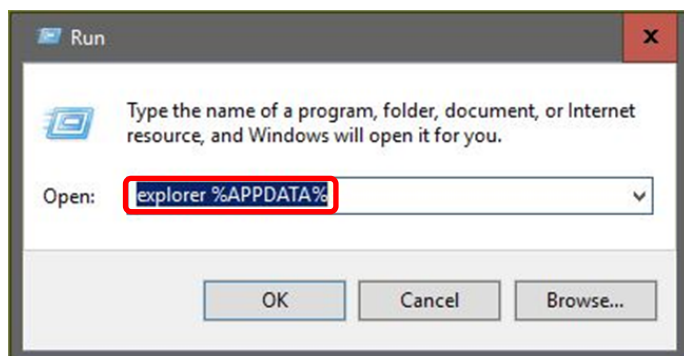

Then browse to the SkyTrack data subdirectory: **White Elephant\SkyTrack**

3.2 Contents of SkyTrack data directory

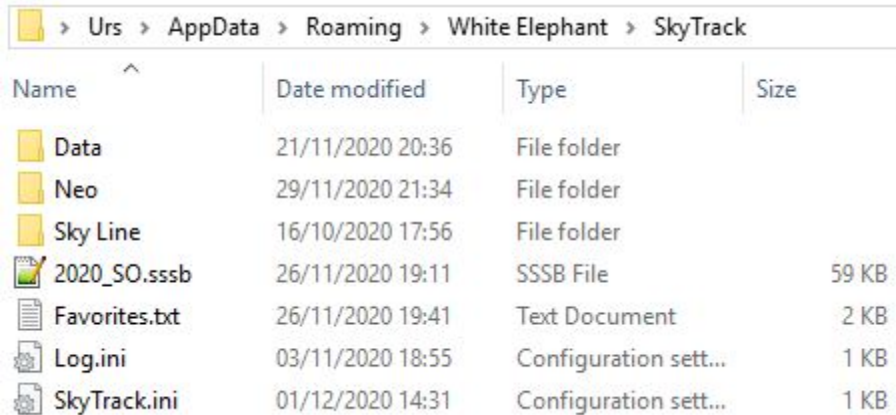

Name	Date modified	Type	Size
Data	21/11/2020 20:36	File folder	
Neo	29/11/2020 21:34	File folder	
Sky Line	16/10/2020 17:56	File folder	
2020_SO.ssb	26/11/2020 19:11	SSSB File	59 KB
Favorites.txt	26/11/2020 19:41	Text Document	2 KB
Log.ini	03/11/2020 18:55	Configuration sett...	1 KB
SkyTrack.ini	01/12/2020 14:31	Configuration sett...	1 KB

This directory contains the following configuration data:

- SkyTrack.ini -> program configuration data
- Favorites.txt -> list of the favorite sky objects
- Log.ini -> configuration of program logging
- Sky Line -> sky line definition data
- Neo -> near earth object information
- Data -> binary program data
- 2020_SO.ssb -> ephemeris for a small solar system body

3.2.1 Program configuration data (SkyTrack.ini)

The file SkyTrack.ini contains information on how to control the telescope. It is automatically generated when SkyTrack is first started. If Stellarium is already installed and configured, its configuration is taken to initialize the language and site information.

The content of the configuration file is split into the sections Localization, Telescope, Stellarium and Site.

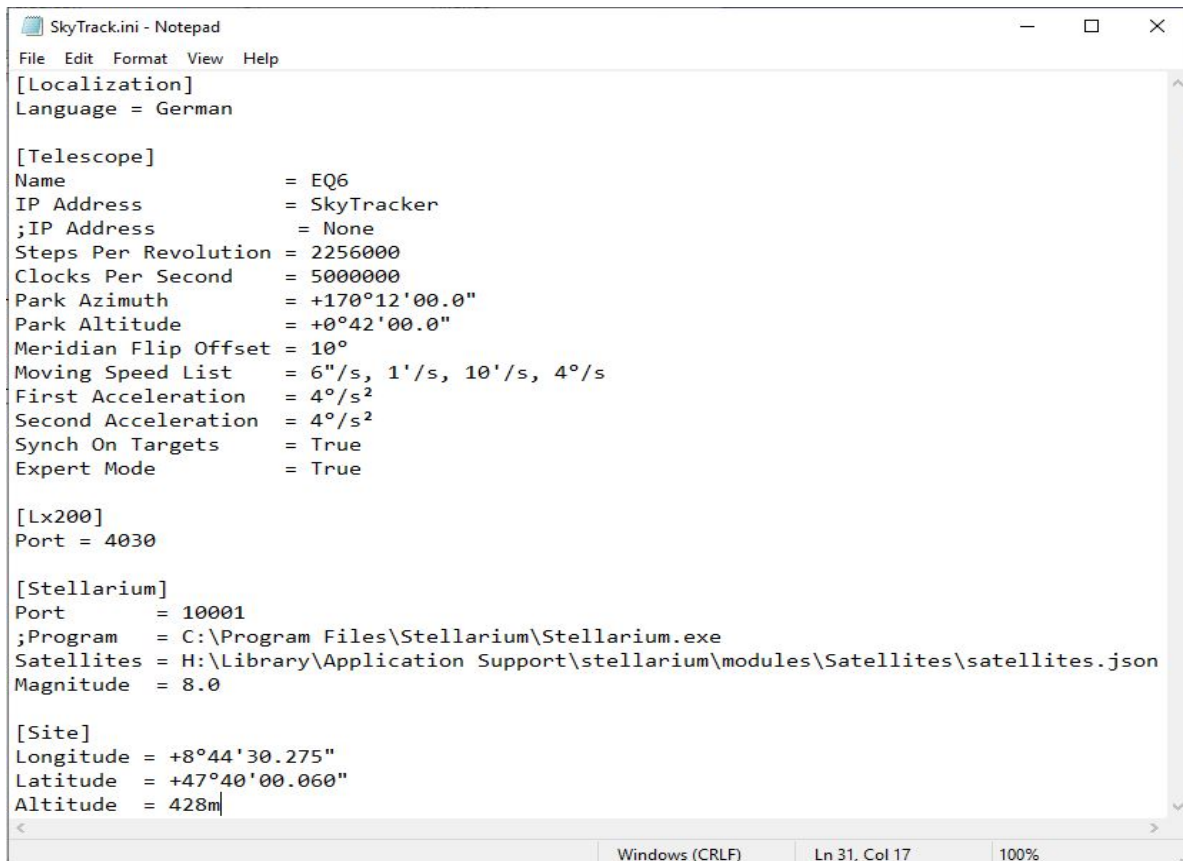

```
SkyTrack.ini - Notepad
File Edit Format View Help
[Localization]
Language = German

[Telescope]
Name = EQ6
IP Address = SkyTracker
;IP Address = None
Steps Per Revolution = 2256000
Clocks Per Second = 5000000
Park Azimuth = +170°12'00.0"
Park Altitude = +0°42'00.0"
Meridian Flip Offset = 10°
Moving Speed List = 6"/s, 1'/s, 10'/s, 4°/s
First Acceleration = 4°/s²
Second Acceleration = 4°/s²
Synch On Targets = True
Expert Mode = True

[Lx200]
Port = 4030

[Stellarium]
Port = 10001
;Program = C:\Program Files\Stellarium\Stellarium.exe
Satellites = H:\Library\Application Support\stellarium\modules\Satellites\satellites.json
Magnitude = 8.0

[Site]
Longitude = +8°44'30.275"
Latitude = +47°40'00.060"
Altitude = 428m

Windows (CRLF) Ln 31, Col 17 100%
```

The Localization section contains:

- **Language** = *<language>*
The language is English, French, German, Greek, Italian or Spanish.

The Telescope section contains the following properties:

- **Name** = *<name>*
The Telescope's *<name>* to be shown in the SkyTrack windows title bar.
- **IP Address** = *<address or name>*
If the name is "SkyTracker" for Windows (or "SkyTracker.local" for Linux and OSX) then SkyTracker hardware must be connected via Ethernet. If the name is "None" then the telescope is simulated.
- **Steps Per Revolution** = *<number>*
Defines the number of micro steps used to turn a telescope axis by 360°. The SkyTracker hardware stepper controller uses 16 micro steps per step.

If the gearing is different per axis the two values must be individually defined.
First Steps Per Revolution = *<number>*
Second Steps Per Revolution = *<number>*
- **Clocks Per Second** = *<number>*
Defines the time resolution of the actual hardware. For the SkyTracker hardware a value of 5,000,000 is used.
- **Park Azimuth** = *<angle>*
Park Altitude = *<angle>*
Park azimuth and altitude define the telescopes park position.
- **Moving Speed List** = *<speed>, <speed>, <speed>, <speed> ...*
An ascending list of speeds is used to manually control the telescope via the arrow keys. The **+** and **-** keys change from one value to the next or previous. The last value of the list is the maximum speed for all movements except when adjusting (movements whilst tracking an object).
- **First Acceleration** = *<acceleration>*
Defines the maximum acceleration for right ascension axis.
- **Second Acceleration** = *< acceleration >*
Defines the maximum acceleration for the declination axis.
- **Meridian Flip Offset** = *<angle>*
Specifies for right ascension offset value for a meridian flip.
- **Synch On Targets** = *<boolean>*
Defines if synch on targets is allowed (**True** or **False**).
- **Expert Mode** = *< boolean >*
Sets the expert mode to **True** or **False**. (See Chapter 4)

The Lx200 section contains:

- **Port** = <number>
Defines the port number for the Lx200 protocol server. This enables a smart phone or tablet computer to control the telescope.

Examples:

SkySafari 5 Pro (Telescope Setup: Scope Type – Meade LX-200 Classic)

The Stellarium section contains:

- **Port** = <number>
Defines the port number used by the Stellarium telescope control.
- **Program** = <path and filename of the Stellarium application (stellarium.exe)>
[optional] If defined Stellarium starts automatically when SkyTrack is started.
- **Satellites** = <path and filename of the satellites data file (satellites.json)>
[optional] If not defined no satellites from Stellarium are added to the NEO list.
- **Magnitude** = <number>
[optional] Defines the magnitude limit for Satellites. If not defined all visible satellites are added to the NEO list.

The Site section contains:

- **Longitude** = <angle>
Latitude = <angle>
Altitude = <angle>
Telescope location information.

3.2.2 Favorites list of Sky Objects (Favorites.txt)

The file Favorites.txt is automatically generated when SkyTrack is first started. In this file, one object per line of text can be defined. Empty lines are allowed.

For example:

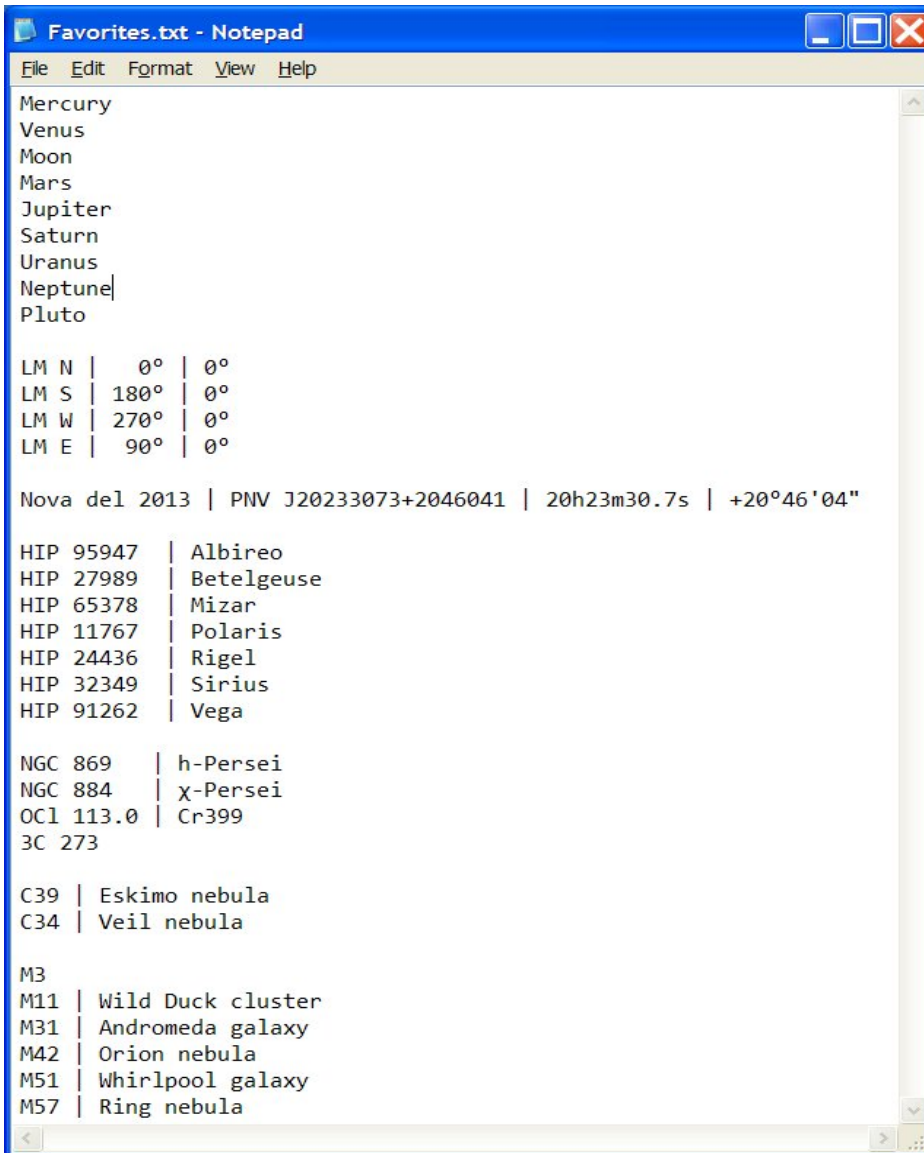

```
Mercury
Venus
Moon
Mars
Jupiter
Saturn
Uranus
Neptune|
Pluto

LM N | 0° | 0°
LM S | 180° | 0°
LM W | 270° | 0°
LM E | 90° | 0°

Nova del 2013 | PMV J20233073+2046041 | 20h23m30.7s | +20°46'04"

HIP 95947 | Albireo
HIP 27989 | Betelgeuse
HIP 65378 | Mizar
HIP 11767 | Polaris
HIP 24436 | Rigel
HIP 32349 | Sirius
HIP 91262 | Vega

NGC 869 | h-Persei
NGC 884 | χ-Persei
OCl 113.0 | Cr399
3C 273

C39 | Eskimo nebula
C34 | Veil nebula

M3
M11 | Wild Duck cluster
M31 | Andromeda galaxy
M42 | Orion nebula
M51 | Whirlpool galaxy
M57 | Ring nebula
```

3.2.3 Solar Objects

For solar objects, any of the following names, in any of the supported languages, are allowed:

- **Sun**
Warning: if no solar filter is in use, the sun **must not be added to the list.**
- **Moon**
- **Mercury**
- **Venus**
- **Mars**
- **Jupiter**
- **Saturn**
- **Neptune**
- **Pluto**

3.2.4 Small Solar System Bodies (SSSB)

A file with the extension **.sssb**, placed in the folder where the file Favorites.txt is located, defines an SSSB. The name can then be added to the favorites list.

Examples:

C2015-V2(Johnson)

3.2.5 Objects from Catalogs

The following syntax defines an object:

<object_id>
or
<object_id> ¦ <name>

For Caldwell and Messier objects the name is appended to the object id. For the other objects the name replaces the object id.

Examples:

HIP 32349 ¦ Sirius (Sirius in favorite list)

M57 ¦ Ring Nebula (M57 Ring Nebula in favorite list)

Objects can be defined from any of the following integrated catalogs.

- Caldwell
- HIP
- HR
- Messier
- NEO
- NGC
- OCI
- Quasars

3.2.6 Sky Objects

The following syntax defines a sky object:

<name> ¦ <description> ¦ <right ascension> ¦ <declination>

Example:

Nova Del 2013 ¦ PNV J20233073+2046041 ¦ 2h23m30.7s ¦ +20°46'04"

3.2.7 On Earth Objects

The id "LM" (Land Marks) starts the definition for stationary objects.

LM <name> ¦ <azimuth> ¦ <altitude>

Examples:

LM Road Sign ¦ 259°43' ¦ 2°38'

LM West ¦ 270° ¦ 0°

3.3 Small Solar System Bodies

A small solar system body (SSSB) is an object in the solar system that is neither a planet, nor a dwarf planet, nor a satellite. For example: comets are small solar system bodies.

To track an SSSB, a table of its future positions - so called ephemerides – has to be downloaded.

3.3.1 Download Ephemerides

The following Web-Interface allows the downloading of ephemerides:

<https://ssd.jpl.nasa.gov/horizons.cgi>

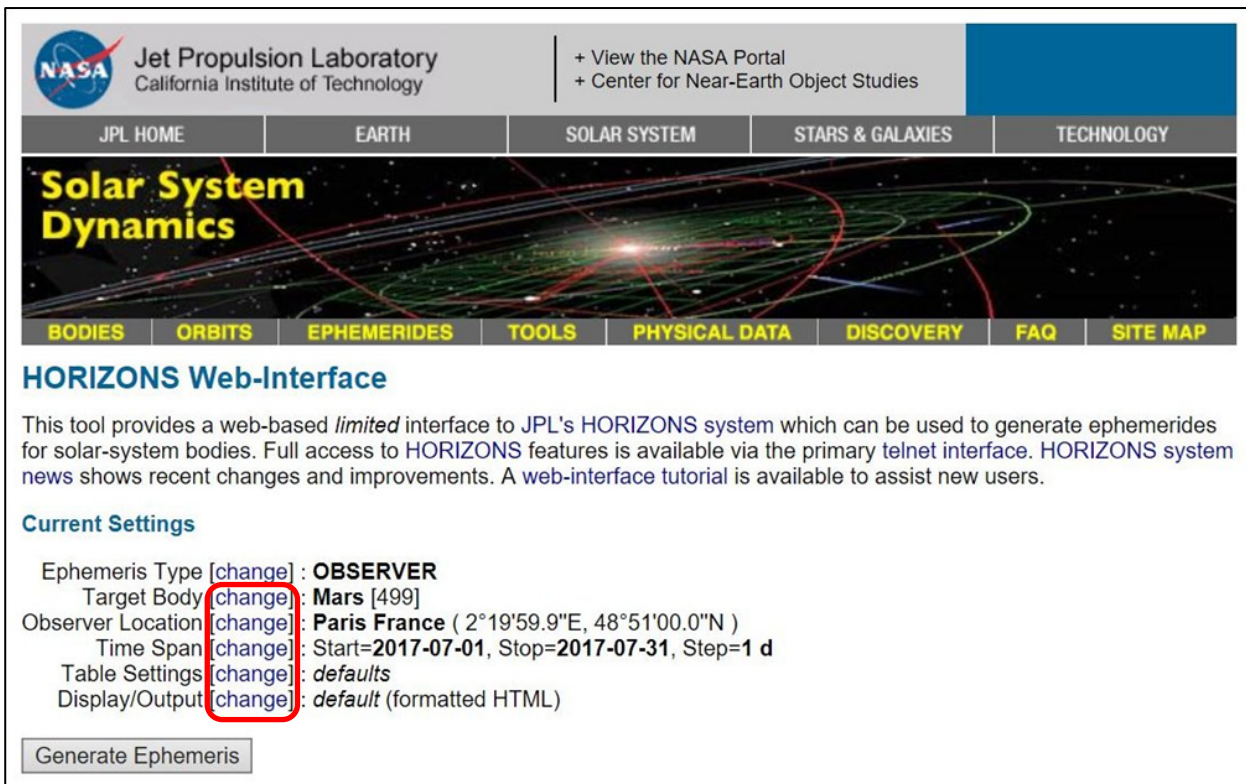

The screenshot shows the JPL Horizons Web-Interface. At the top, there is a NASA logo and the text "Jet Propulsion Laboratory California Institute of Technology". Below this is a navigation bar with links for "JPL HOME", "EARTH", "SOLAR SYSTEM", "STARS & GALAXIES", and "TECHNOLOGY". The main content area features a "Solar System Dynamics" header and a navigation bar with links for "BODIES", "ORBITS", "EPHEMERIDES", "TOOLS", "PHYSICAL DATA", "DISCOVERY", "FAQ", and "SITE MAP". The "EPHEMERIDES" section is active, displaying "Current Settings" for the "HORIZONS Web-Interface". The settings are: Ephemeris Type [change]: **OBSERVER**; Target Body [change]: **Mars [499]**; Observer Location [change]: **Paris France (2°19'59.9"E, 48°51'00.0"N)**; Time Span [change]: Start=**2017-07-01**, Stop=**2017-07-31**, Step=**1 d**; Table Settings [change]: **defaults**; Display/Output [change]: **default (formatted HTML)**. A "Generate Ephemeris" button is located at the bottom of the settings section.

3.3.1.1 Change Target Body

Target Body

Lookup the specified body:

optionally limit to

3.3.1.2 Change Observer Location

Specify Observer Location:

You can specify a topocentric observer location by choosing from a list of major world cities, by choosing from a list of world-wide observatories, or by giving the latitude, longitude, and altitude. You can also specify non-topocentric Horizons-specific location codes such as the sun or another planet.

Please select from from the following list:

- lookup a named location
- choose from a list of locations
- **specify latitude, longitude, and altitude**

Specify Observer Coordinates

*Longitude and Latitude can be entered as either "degrees minutes seconds" or decimal degrees. In either case, they should always be positive and use the appropriate East/West and North/South selections. If entering "degrees minutes seconds" use spaces or commas between elements. If *Altitude* is unknown, zero can be used for optical sites without much loss of accuracy.*

Longitude: degrees East West
 Latitude: degrees North South
 Altitude: kilometers above the reference ellipsoid (WGS-84, or approx. sea level for Earth)
 Body ID: Horizons body ID of the central body: e.g. '399' for Earth, '499' for Mars)

3.3.1.3 Change Time Span

Time Span
switch to discrete-times form

Preset:

Start Time:

Stop Time:

Step Size:

Available time span for currently selected target body:
1599-Dec-12 to 2500-Dec-30 TT.

Times may be specified as calendar dates and optionally times (e.g. "YYYY{BC|AD}-MM-DD {hh:mm} {UT|TT}"), or Julian dates (e.g. "{JD } DDDDDDD.DDDDD") where items in curly braces {} are optional. For years earlier than 1000, be sure to append 'AD' (or 'BC' as appropriate). Unless otherwise specified, UT is assumed for OBSERVER tables.

See the [HORIZONS documentation](#) for accepted formats and advanced capabilities. Allowable time-spans for all bodies are available on a [separate page](#).

3.3.1.4 Change Table Settings

<input checked="" type="checkbox"/> 1. Astrometric RA & DEC	<input type="checkbox"/> 16. Sub-Sun position angle & distance	* <input type="checkbox"/> 31. Observer ecliptic lon. & lat.
* <input type="checkbox"/> 2. Apparent RA & DEC	<input type="checkbox"/> 17. North Pole position angle & distance	<input type="checkbox"/> 32. North pole RA & DEC
<input type="checkbox"/> 3. Rates; RA & DEC	<input type="checkbox"/> 18. Heliocentric ecliptic lon. & lat.	<input type="checkbox"/> 33. Galactic longitude & latitude
* <input type="checkbox"/> 4. Apparent AZ & EL	<input type="checkbox"/> 19. Heliocentric range & range-rate	<input type="checkbox"/> 34. Local apparent SOLAR time
<input type="checkbox"/> 5. Rates; AZ & EL	<input type="checkbox"/> 20. Observer range & range-rate	<input type="checkbox"/> 35. Earth->obs. site light-time
<input type="checkbox"/> 6. Satellite X & Y, pos. angle	<input type="checkbox"/> 21. One-way (down-leg) light-time	> <input type="checkbox"/> 36. RA & DEC uncertainty
<input type="checkbox"/> 7. Local apparent sidereal time	<input type="checkbox"/> 22. Speed wrt Sun & observer	> <input type="checkbox"/> 37. Plane-of-sky error ellipse
<input type="checkbox"/> 8. Airmass & extinction	<input type="checkbox"/> 23. Sun-Observer-Target ELONG angle	> <input type="checkbox"/> 38. POS uncertainty (RSS)
<input type="checkbox"/> 9. Visual mag. & Surface Brght	<input type="checkbox"/> 24. Sun-Target-Observer ~PHASE angle	> <input type="checkbox"/> 39. Range & range-rate 3-sigmas
<input type="checkbox"/> 10. Illuminated fraction	<input type="checkbox"/> 25. Target-Observer-Moon angle/ Illum%	> <input type="checkbox"/> 40. Doppler & delay 3-sigmas
<input type="checkbox"/> 11. Defect of illumination	<input type="checkbox"/> 26. Observer-Primary-Target angle	<input type="checkbox"/> 41. True anomaly angle
<input type="checkbox"/> 12. Satellite angular separ/vis.	<input type="checkbox"/> 27. Sun-Target radial & -vel pos. angle	<input type="checkbox"/> 42. Local apparent hour angle
<input type="checkbox"/> 13. Target angular diameter	<input type="checkbox"/> 28. Orbit plane angle	<input type="checkbox"/> 43. PHASE angle & bisector
<input type="checkbox"/> 14. Observer sub-lon & sub-lat	<input type="checkbox"/> 29. Constellation ID	
<input type="checkbox"/> 15. Sun sub-longitude & sub-latitude	<input type="checkbox"/> 30. Delta-T (TDB - UT)	

Notes:
 * affected by optional atmospheric refraction setting (below)
 > statistical value that uses orbit covariance if available

Observer quantities are described in the [HORIZONS documentation](#).

Optional observer-table settings:

date/time format :	both	-- display date/time in year-month-day and/or Julian-day format
time digits :	minutes (HH:MM)	-- controls output precision of time
angle format :	decimal degrees	-- select RA/Dec output format
output units :	km & km/s	-- units for most output quantities
range units :	astronomical units	-- units for range-type quantities
refraction model :	airless model (no refraction)	-- select atmospheric refraction model
airmass cut-off :		-- suppress output when airmass is greater than limit [1 to 38]
elevation cutoff :	0	(deg) -- suppress output when object elevation is less than limit [-90 to 90]
solar elong. cut-off :		(deg) -- suppress output when solar elongation is outside (min,max) range [0 to 180, min to 180]
hour angle cutoff :		(h) -- suppress output when the local hour angle (LHA) exceeds value [0 to 12]
angular rate cutoff :		(arcsec/h) -- suppress output when the RA/Dec angular rate exceeds this value [0 to 100000]
suppress range-rate :	<input type="checkbox"/>	-- suppress range-rate for range/range-rate output
skip daylight :	<input type="checkbox"/>	-- suppress output during daylight
extra precision :	<input type="checkbox"/>	-- output addition digits for RA/Dec quantities
RTS flag :	disable	-- output data only at target rise/transit/set (RTS)
reference system :	ICRF/J2000.0	-- reference frame for geometric and astrometric quantities
CSV format :	<input checked="" type="checkbox"/>	-- output data in Comma-Separated-Values (CSV) format
object page :	<input checked="" type="checkbox"/>	-- include object information/data page on output

3.3.1.5 Change Display/Output

<input type="radio"/> HTML (default)	Ephemeris results will be shown in a normal formatted web page.
<input type="radio"/> plain text	Ephemeris results will be displayed as plain text (ASCII).
<input checked="" type="radio"/> download/save	Ephemeris results will be saved to a local file (this assumes your browser supports file downloads)

3.3.1.6 Generate Ephemerides

Current Settings

Ephemeris Type [change] : **OBSERVER**
 Target Body [change] : **Comet C/2015 V2 (Johnson)**
 Observer Location [change] : user defined (8°36'35.5"E, 47°42'19.8"N, 0.54 km)
 Time Span [change] : Start=2017-07-11, Stop=2017-09-09, Step=1 h
 Table Settings [change] : QUANTITIES=1; date/time format=BOTH; angle format=DEG; elevation cutoff=0; CSV format=YES
 Display/Output [change] : **download/save** (plain text file)

Do you want to open or save **horizons_results.txt** from **ssd.jpl.nasa.gov**?

The new file **horizons_result.txt** can now be renamed to **C2015-V2(Johnson).sssb** and then placed in the same folder where the file **Favorites.txt** is located. Then the name **C2015-V2(Johnson)** can be added to the favorites list.

4 Telescope Setup

To enable a telescope setup the mode has to be changed to expert mode. This can be achieved by setting the expert mode to **True** in the SkyTrack.ini file.

After the next start of SkyTrack the following should be visible:

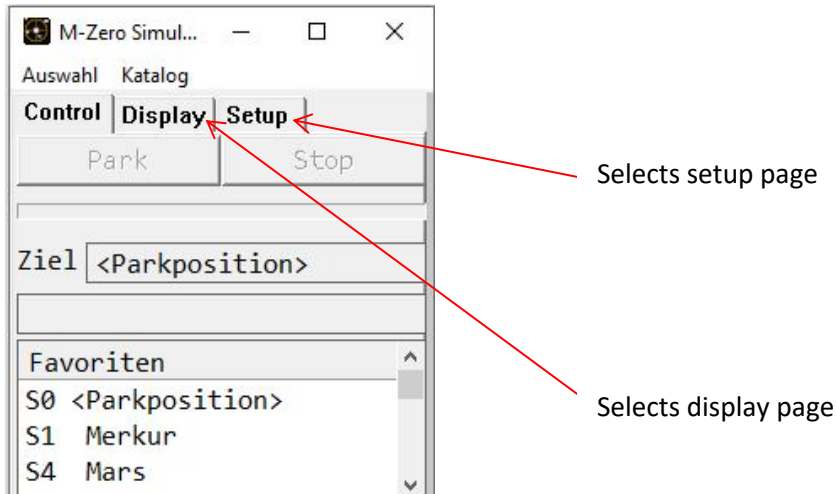

4.1 Display Page

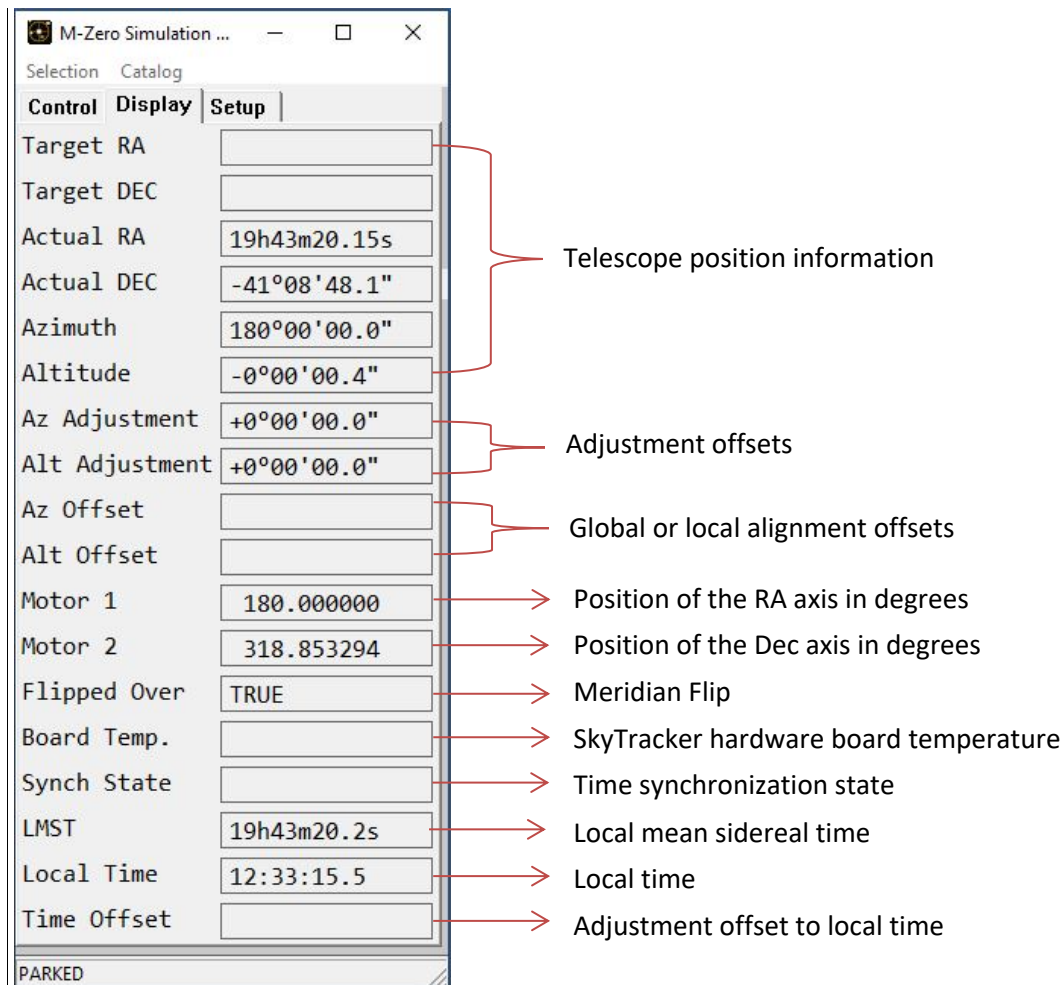

4.2 Setup Page

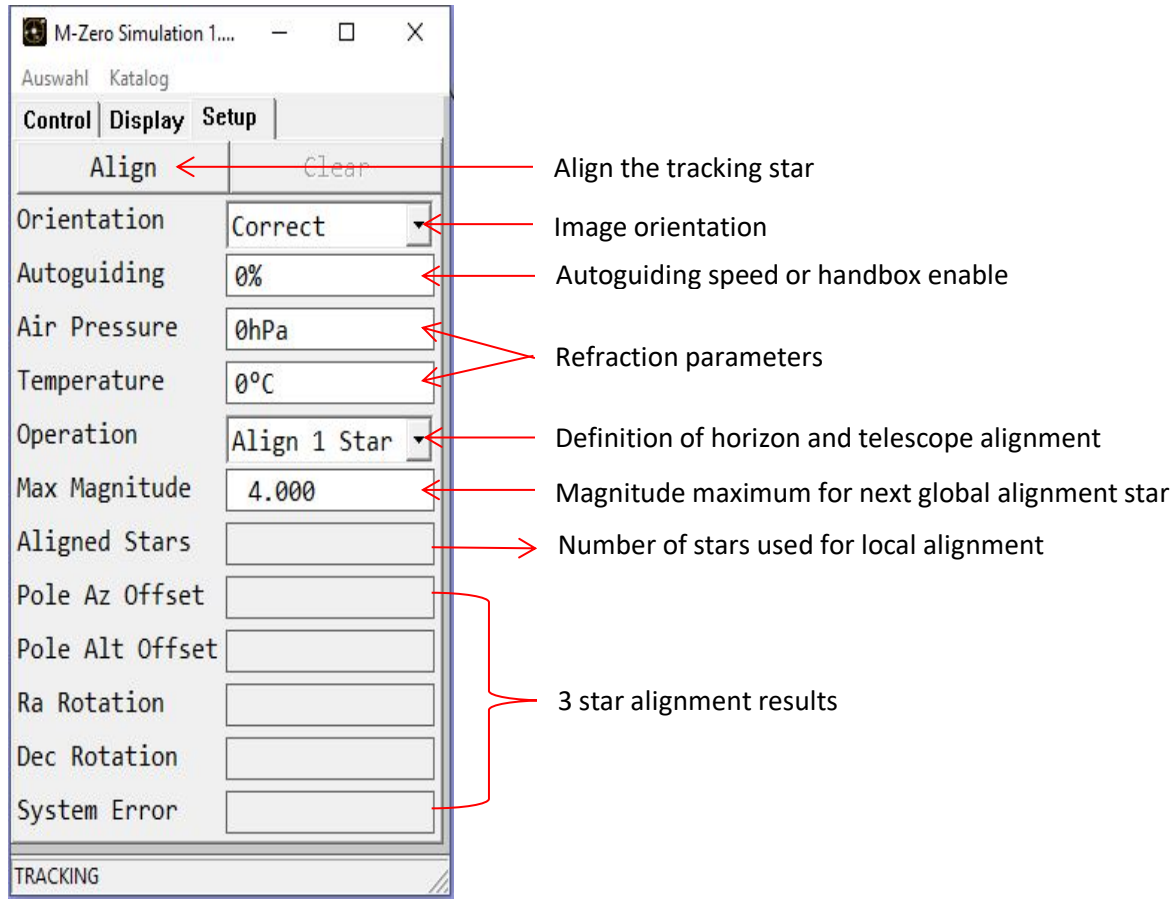

4.2.1 Image Orientation

Whilst tracking, the meaning of the arrow keys to adjust a sky object can be changed. The pull-down menu allows the selection of one of the following image orientations:

- **Correct**
- **Upside Down** Up - Down keys swapped.
- **Backwards** Left - Right keys swapped.
- **Rotated** Up - Down and Left - Right keys swapped.

4.2.2 Autoguiding Speed

The speed for autoguiding is defined in arc seconds per second. A typical value would be **8"/s**. A value of **0"/s** allows the use of a handbox instead of an autoguiding camera.

4.2.3 Refraction Parameters

Two parameters are used to correct the refraction.

- Air Pressure in hecto Pascal
- Temperature in degrees Celsius

A value of zero for the air pressure switches off the refraction corrections.

4.2.4 Setup Operation

One of the following operations can be selected (see corresponding chapter for more information).

- **Align 1 Star** to Synch to the tracking object (clears the adjustment offsets).
- **Align Pole Axis** to adjust the pole axis (only for equatorial mounts).
- **Align Global** alignment using many stars to generate a global correction matrix.
- **Align Local** local alignment (if autoguiding is not possible).
- **Set Sky Line** to define the actual horizon.

4.3 Pole Axis Alignment

To align the pole axis of an equatorial mount three stars have to be aligned. The stars should not be close to the pole or zenith and the altitude should be greater than 30 degrees. After aligning the third star, the telescope is positioned so that mechanically aligning it back to the third star the pole axis will be aligned. The Synch button allows synchronizing the RA and Dec axis. The System Error depends on the quality of the telescope and how precise the aligning was done. If the error is too big the Clear button can be used to allow a new alignment procedure

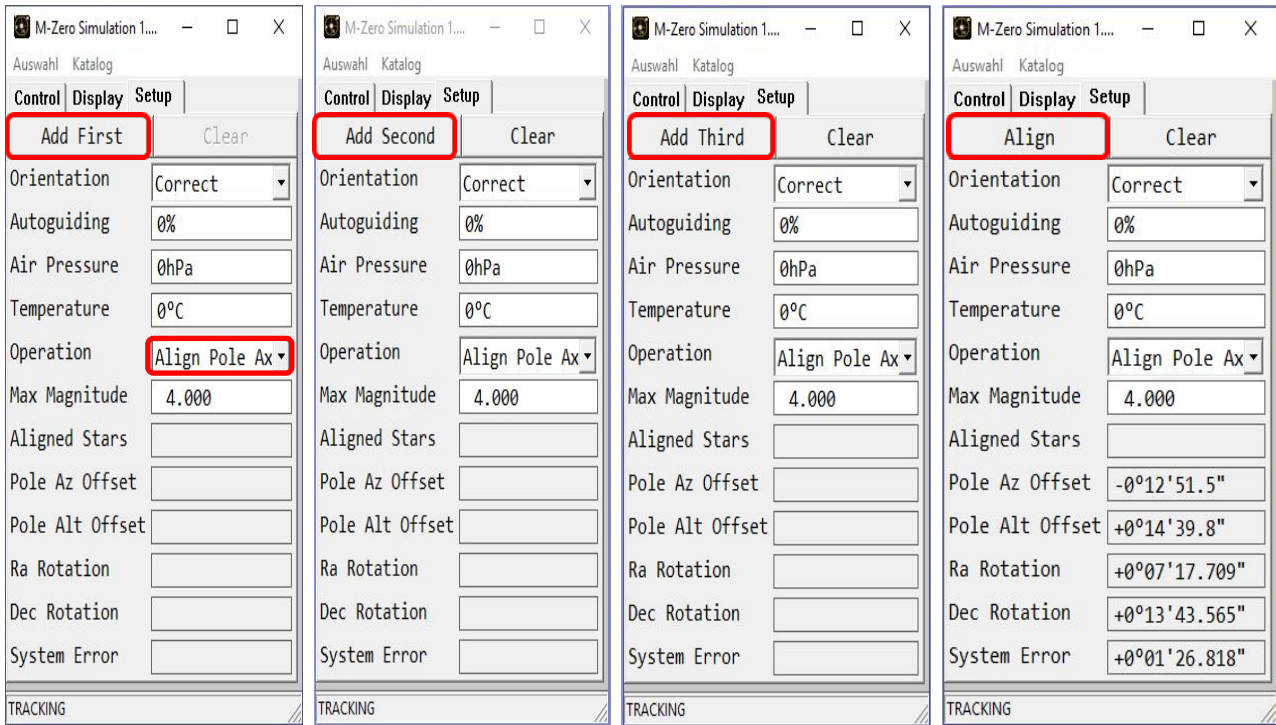

4.4 Local Alignment

If autoguiding is not possible, local alignment can be used to position the telescope more precisely in a local area. At least five stars have to be aligned. After the telescope is stopped the Apply button completes the operation.

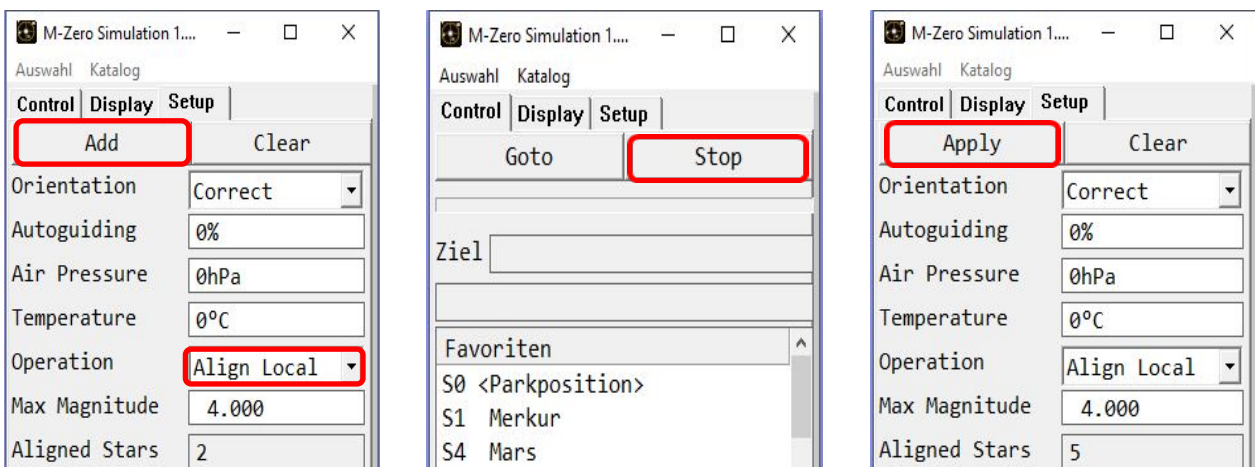

4.5 Global Alignment

The global alignment operation allows the alignment of typically around 50 stars to build a global correction matrix. The alignment information is added to a file called **New_Data.txt** in the alignment folder in the SkyTrack application data area. To keep the file it can be renamed.

After the Align Global operation is selected the next tracked star enables the adding of alignment data. The next star is positioned automatically according to the first star's altitude and the chosen maximum magnitude. If there are no more stars to add in the current altitude band, the operation can be restarted to add data at a different altitude. The Next button allows going to the next star without adding the data of the actual star.

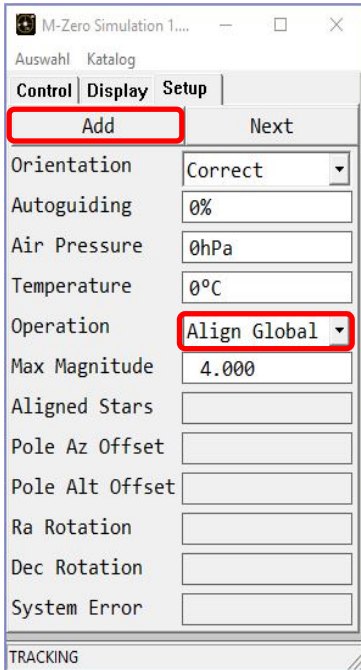

The screenshot shows a file explorer window with the path '<< AppData > Roaming > White Elephant > SkyTrack > Alignment'. The table below lists the files in this folder:

Name	Date modified	Type
Data.txt	31/05/2019 18:26	Text Document
New_Data.txt	31/05/2019 18:26	Text Document

To use the Information for a global correction matrix the file has to be renamed to **Data.txt** and SkyTrack has to be restarted.

4.6 Set Sky Line

To define the actual horizon the telescope has to be directed to landmarks at the horizon and then by pushing the add button added to the database. The database is located in the sky line folder of the SkyTrack application data area.

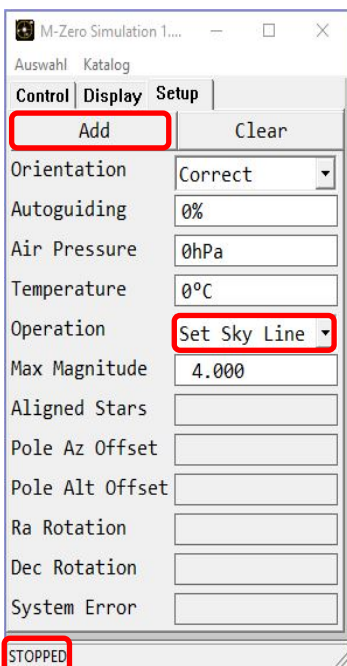

The screenshot shows a file explorer window with the path '<< AppData > Roaming > White Elephant > SkyTrack > Sky Line'. The table below lists the files in this folder:

Name	Date modified	Type
Home.csv	24/10/2018 21:31	CSV File
Horizon.csv	24/10/2018 21:31	CSV File
New_Horizon.csv	31/05/2019 18:40	CSV File

The New_Horizon.csv file has to be renamed to **Horizon.csv** and then SkyTrack has to be restarted.

5 Hardware

5.1 Stepper Controller

The SkyTracker controller is connected via Ethernet to a PC running the SkyTrack program. A handbox or an autoguider can be connected to the guider input.



5.1.1 Power and Ethernet Connections

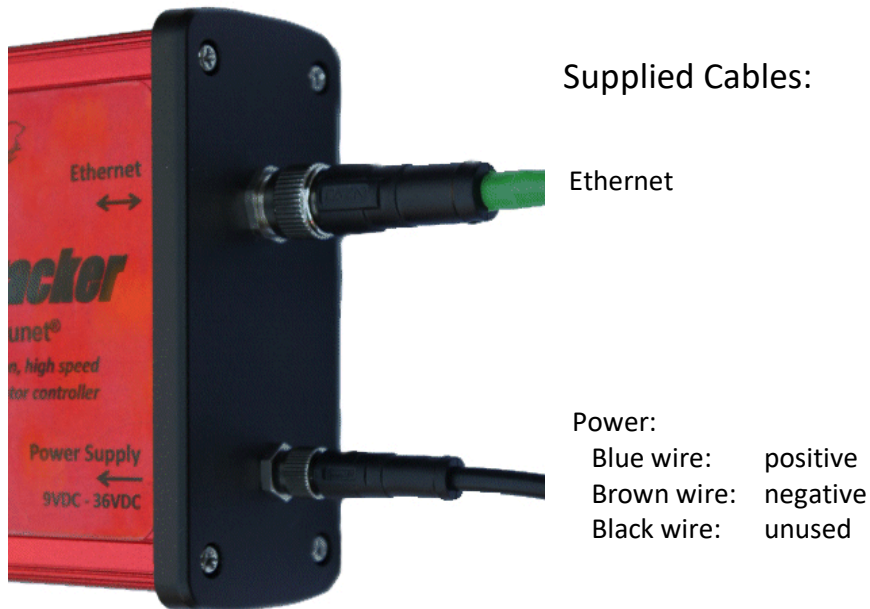

5.1.2 Motor and Guider Connections

Supplied Cables:

Motors:

- White and Brown wires: Coil A
- Black and Blue wires: Coil B

Guider:

- Brown wire: ST4 Yellow
- Green wire: ST4 Blue
- Pink wire: ST4 Green
- Blue wire: ST4 Red
- Red wire: ST4 Black

Sync:

- Yellow wire: Pulse
- Red wire: GND



To change the direction of the motor rotation either the white and brown or the black and blue wires must be swapped. The ST4 wiring for the RJ12 connector is documented in chapter 5.2.2.

The sync pulse can be used to synchronize the internal clock to an external time reference - further details on request.

The white and grey wires are reserved for future development. These must be left disconnected.

5.1.3 Stepper Controller Board

Two potentiometers on the controller board are used to adjust the current of the stepper motors.

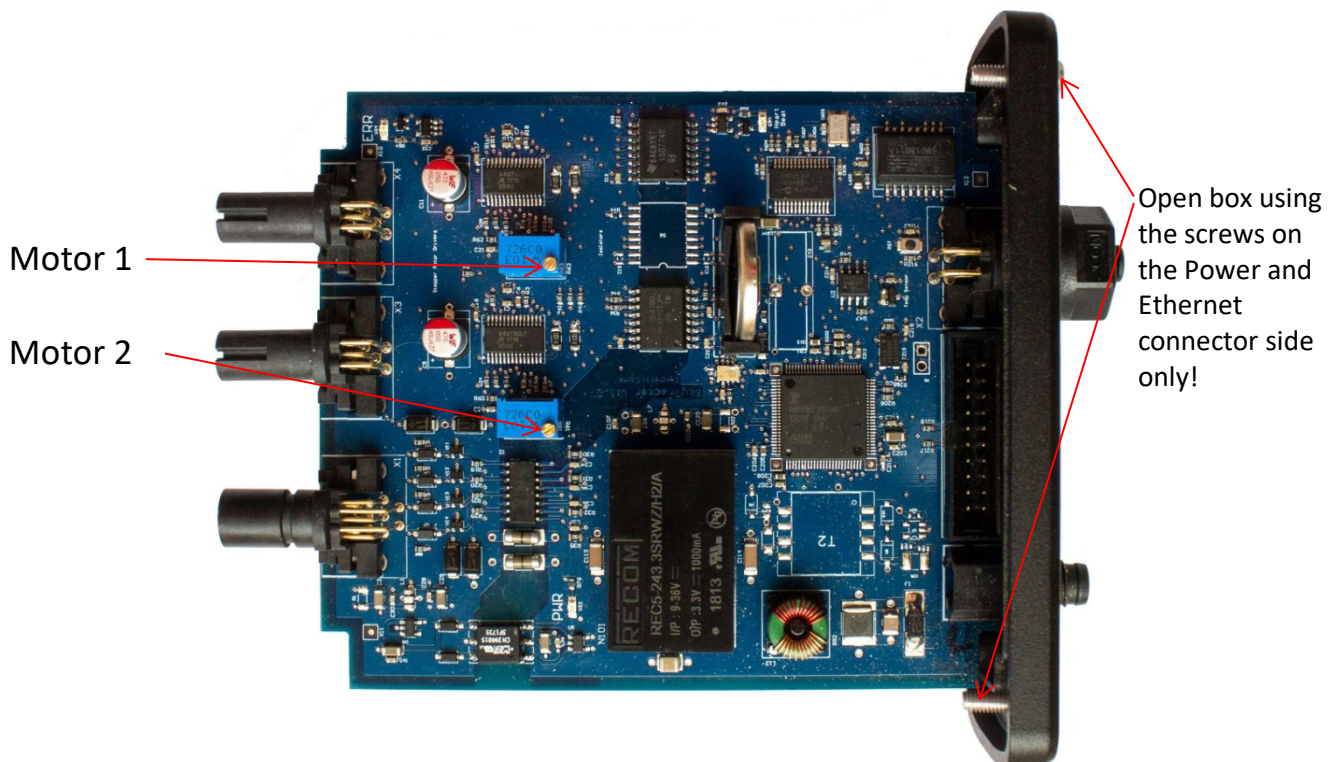

5.2 Handbox

The following pictures show a possible handbox implementation.

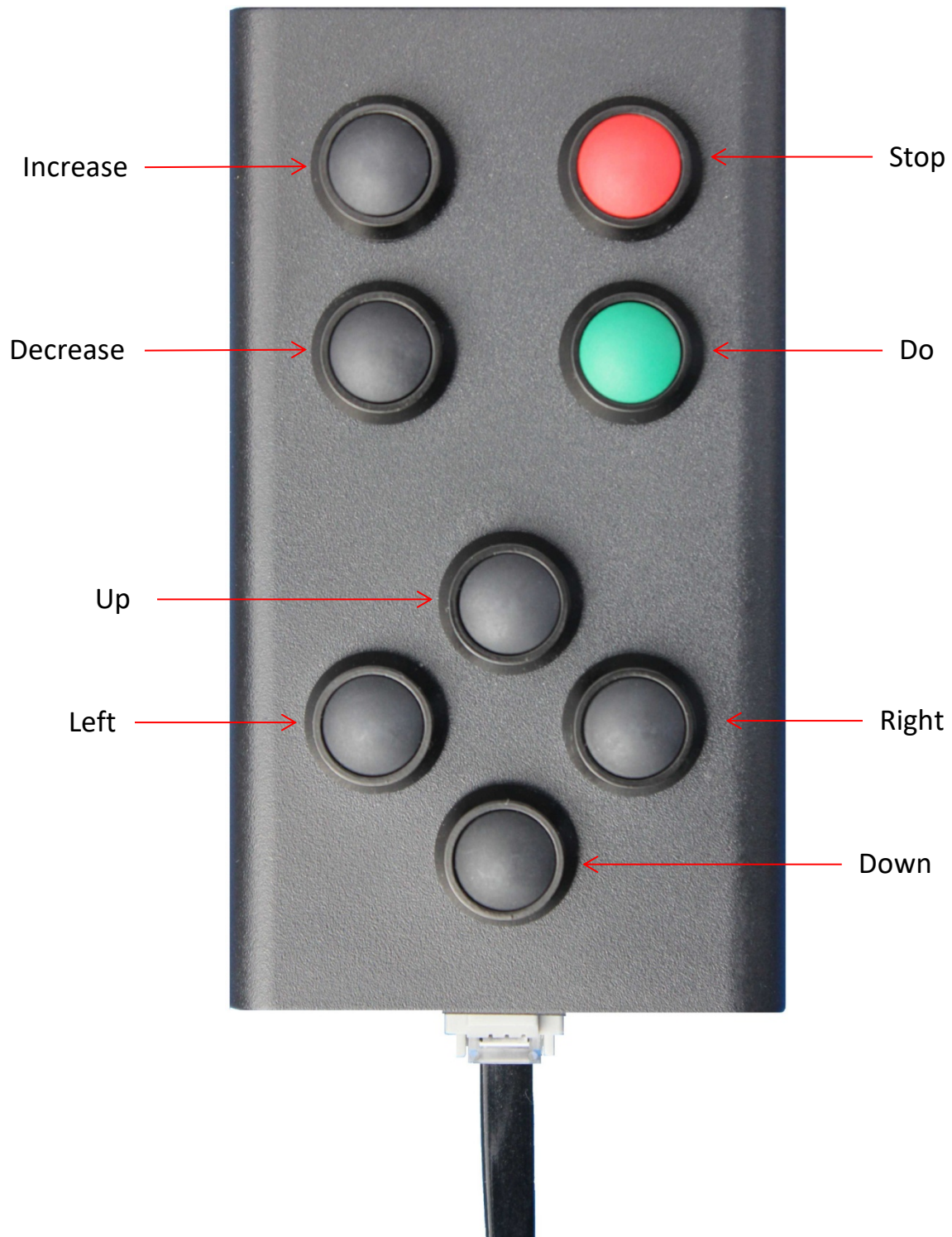

5.2.1 Handbox Inside

Diode

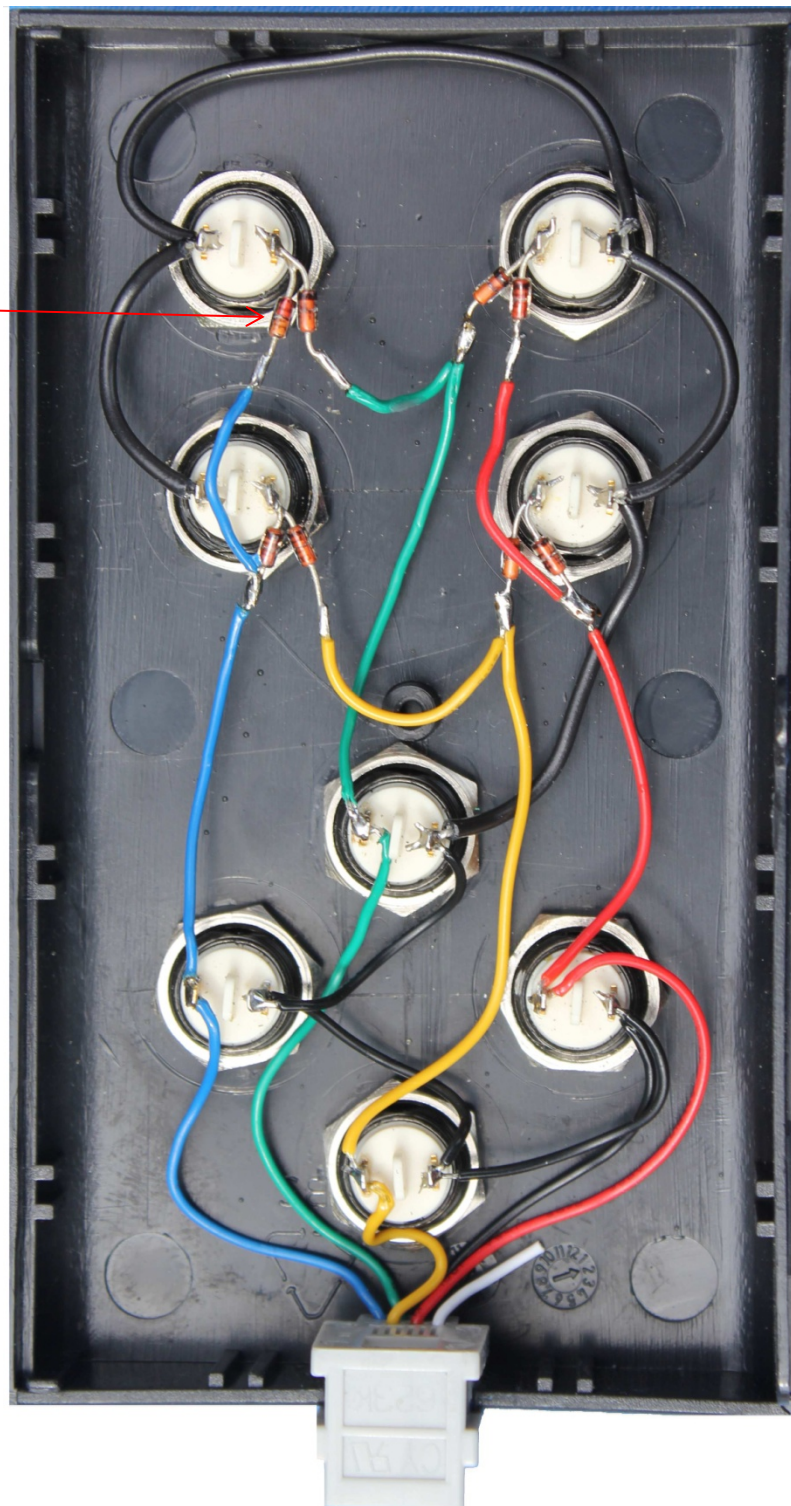

5.2.2 Handbox Schematics

The handbox is shown from the back (left and right is swapped).
For the diodes the type 1N4148 could be used.

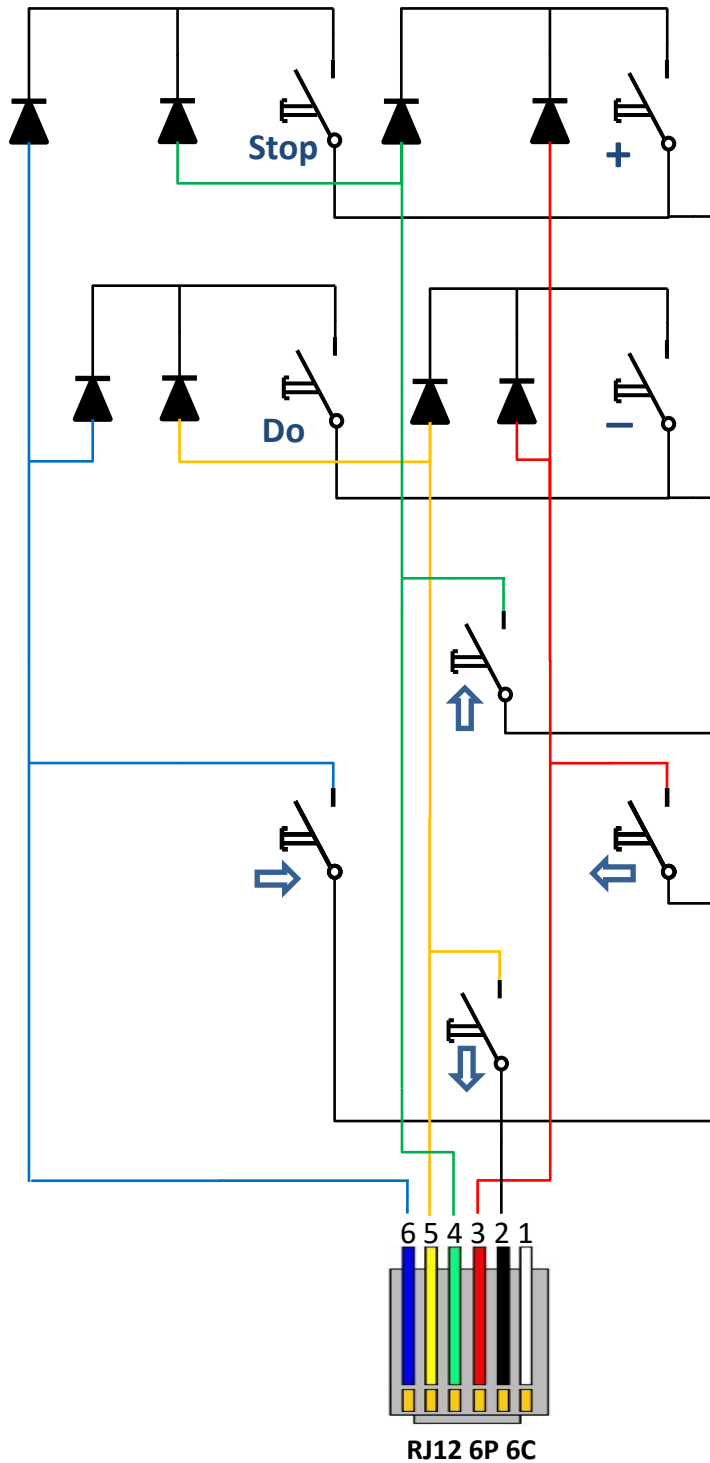

RJ12 wiring for autoguiding (ST4) with supplied Guider Cable:

- 1 – Not connected
- 2 – Red wire
- 3 – Blue wire
- 4 – Pink wire
- 5 – Brown wire
- 6 – Green wire

6 Legacy Hardware

6.1 Stepper Controller

The SkyTracker controller is connected via Ethernet to a PC running the SkyTrack program. A handbox or an autoguider (ST4) can be connected to the guider input.



6.1.1 Stepper Controller Board

Two potentiometers on the controller board are used to adjust the current of the stepper motors.

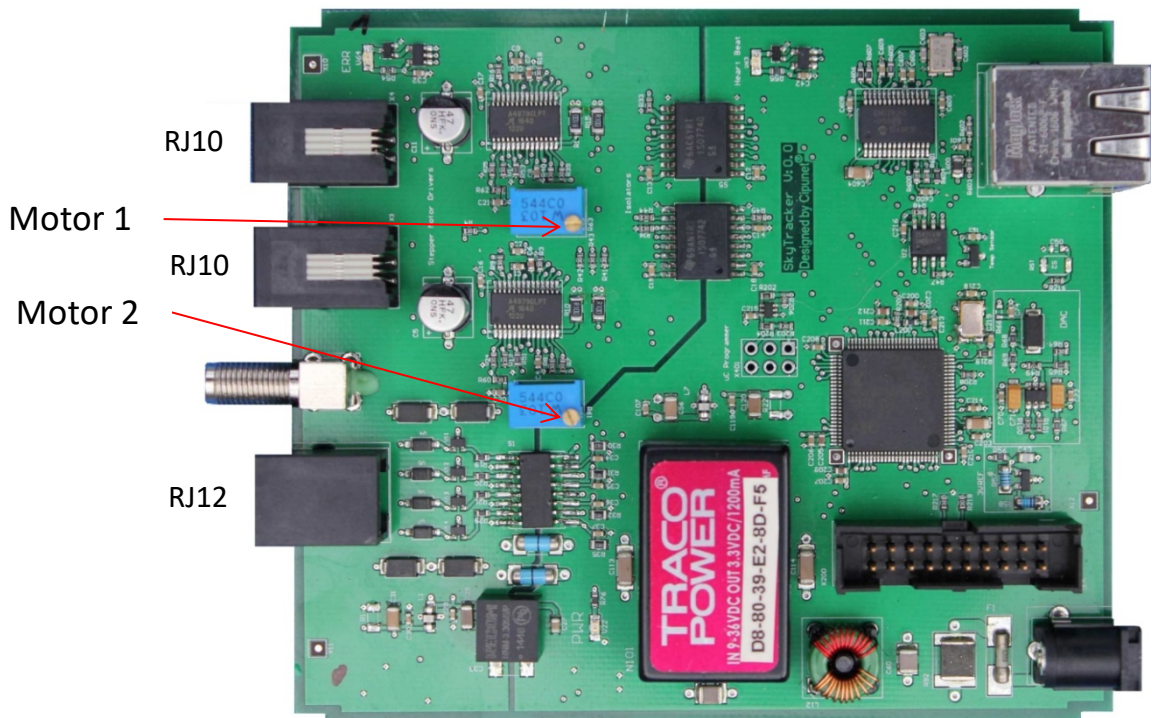

The stepper motors coil A (B) have to be connected to pins 1 and 2 (3 and 4) of the RJ10 connectors. To change the direction of rotation either the connections 1 and 2 or else 3 and 4 must be swapped.